



CHRYSLER PACIFICA

Rear Side Window Deflectors

Deflector de ventana lateral

Déflecteur de la glace latérale



A 1x



B 1x

ALCOHOL PREP PAD
PREPARED FOR USE WITH 70% ISOPROPYL ALCOHOL. DO NOT USE WITH OTHER ALCOHOLS. THIS PRODUCT IS NOT TO BE USED ON PAPER OR OTHER ABSORBENT MATERIALS. IT IS NOT TO BE USED ON SURFACES THAT ARE OILY OR GREASY. IT IS NOT TO BE USED ON SURFACES THAT ARE PAINTED OR COATED. IT IS NOT TO BE USED ON SURFACES THAT ARE PLASTIC OR VINYL. IT IS NOT TO BE USED ON SURFACES THAT ARE RUBBER OR GLASS. IT IS NOT TO BE USED ON SURFACES THAT ARE METAL OR WOOD. IT IS NOT TO BE USED ON SURFACES THAT ARE FABRIC OR LEATHER. IT IS NOT TO BE USED ON SURFACES THAT ARE STONE OR CONCRETE. IT IS NOT TO BE USED ON SURFACES THAT ARE CERAMIC OR ENAMEL. IT IS NOT TO BE USED ON SURFACES THAT ARE POLISHED OR SHINED. IT IS NOT TO BE USED ON SURFACES THAT ARE OILED OR GREASED. IT IS NOT TO BE USED ON SURFACES THAT ARE OXIDIZED OR RUSTED. IT IS NOT TO BE USED ON SURFACES THAT ARE CORRODED OR ERODED. IT IS NOT TO BE USED ON SURFACES THAT ARE CRACKED OR CHIPPED. IT IS NOT TO BE USED ON SURFACES THAT ARE DISCOLORED OR STAINED. IT IS NOT TO BE USED ON SURFACES THAT ARE DAMAGED OR WEARIED. IT IS NOT TO BE USED ON SURFACES THAT ARE UNCLEAN OR DIRTY. IT IS NOT TO BE USED ON SURFACES THAT ARE UNSTABLE OR UNRELIABLE. IT IS NOT TO BE USED ON SURFACES THAT ARE UNSAFE OR HAZARDOUS. IT IS NOT TO BE USED ON SURFACES THAT ARE ILLEGAL OR UNLAWFUL. IT IS NOT TO BE USED ON SURFACES THAT ARE UNETHICAL OR UNMORAL. IT IS NOT TO BE USED ON SURFACES THAT ARE UNREASONABLE OR UNFAIR. IT IS NOT TO BE USED ON SURFACES THAT ARE UNJUST OR UNWARRANTED. IT IS NOT TO BE USED ON SURFACES THAT ARE UNNECESSARY OR UNWARRANTED. IT IS NOT TO BE USED ON SURFACES THAT ARE UNDESIRABLE OR UNWARRANTED. IT IS NOT TO BE USED ON SURFACES THAT ARE UNACCEPTABLE OR UNWARRANTED. IT IS NOT TO BE USED ON SURFACES THAT ARE UNAPPROPRIATE OR UNWARRANTED. IT IS NOT TO BE USED ON SURFACES THAT ARE UNREASONABLE OR UNWARRANTED. IT IS NOT TO BE USED ON SURFACES THAT ARE UNJUST OR UNWARRANTED. IT IS NOT TO BE USED ON SURFACES THAT ARE UNNECESSARY OR UNWARRANTED. IT IS NOT TO BE USED ON SURFACES THAT ARE UNDESIRABLE OR UNWARRANTED. IT IS NOT TO BE USED ON SURFACES THAT ARE UNACCEPTABLE OR UNWARRANTED. IT IS NOT TO BE USED ON SURFACES THAT ARE UNAPPROPRIATE OR UNWARRANTED.

C 2x

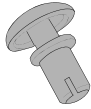

D 4x

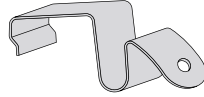

E 4x

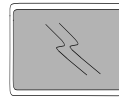

F 4x

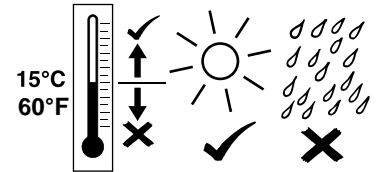

WAIT 24 HOURS BEFORE WASHING VEHICLE
ESPERE 24 HORAS ANTES DE LAVAR EL VEHICULO
ATTENDRE 24 HEURES AVANT DE LAVER LE VEHICULE

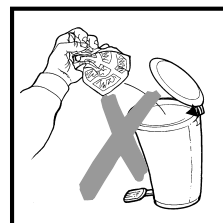
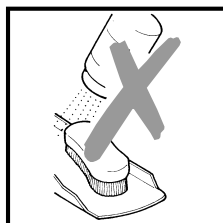
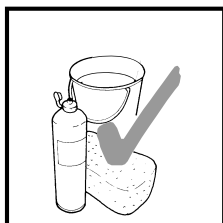
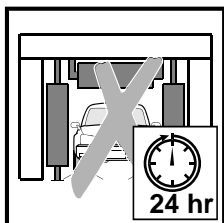

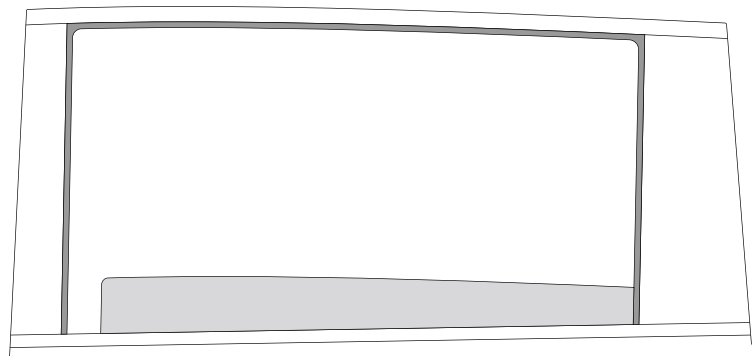
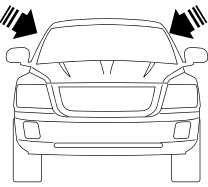
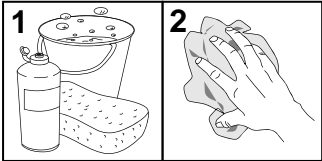

1

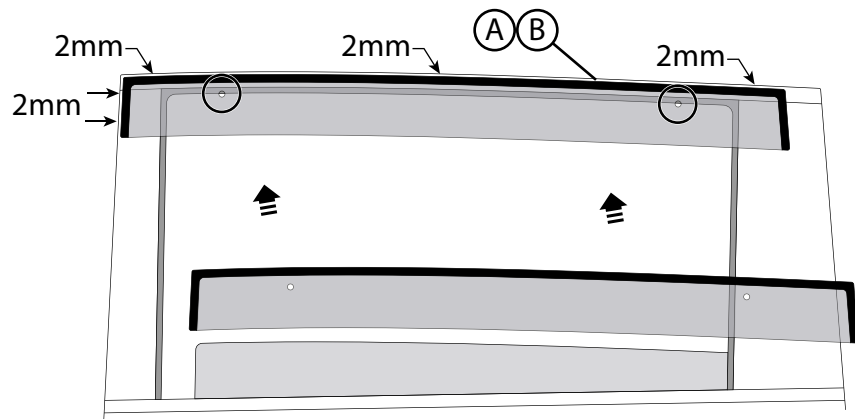
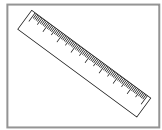
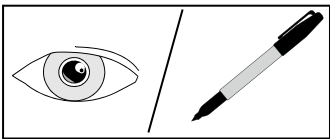

2

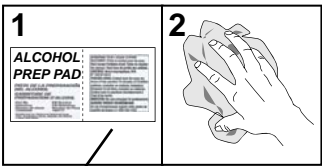

C

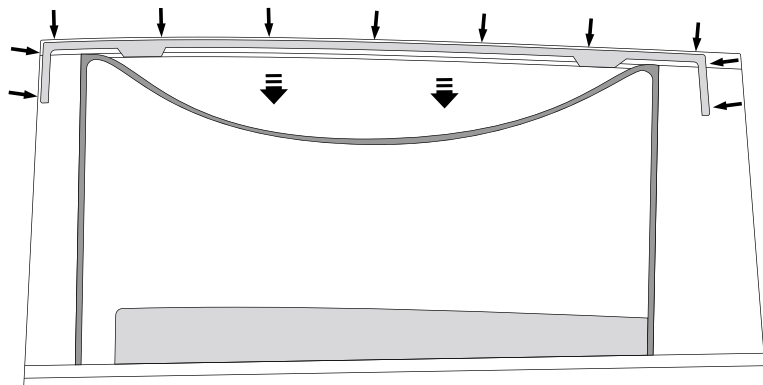

3

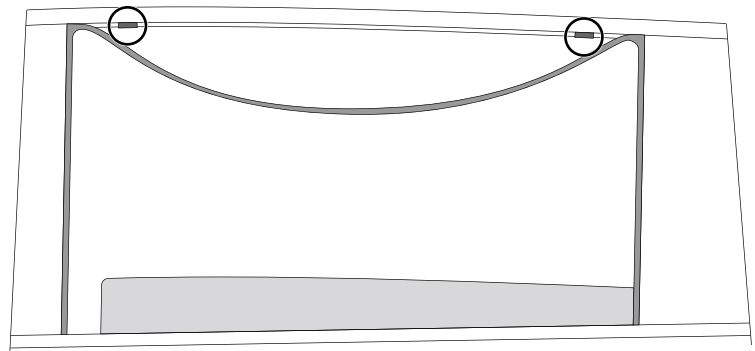
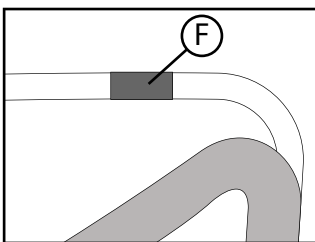
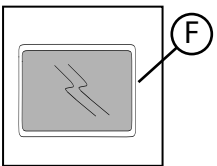

4

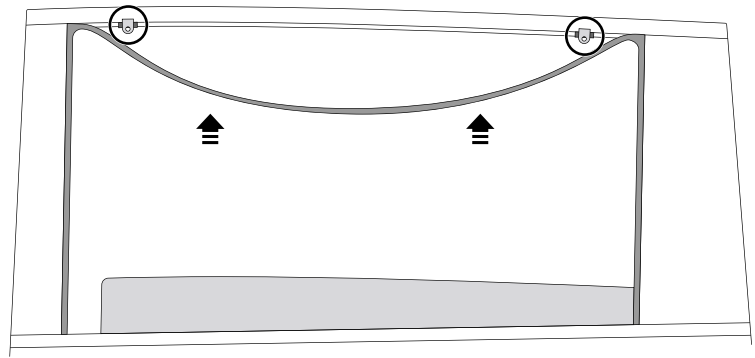
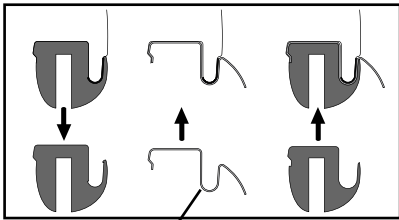
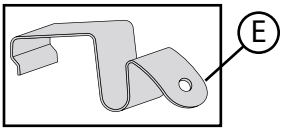

5

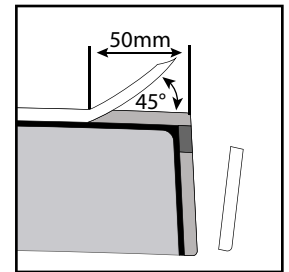
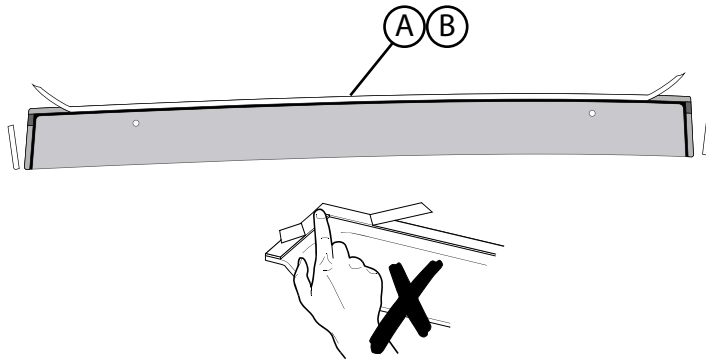
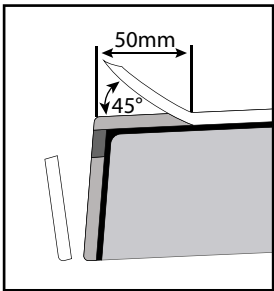

6

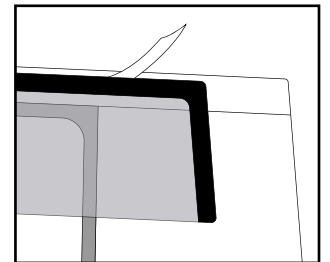
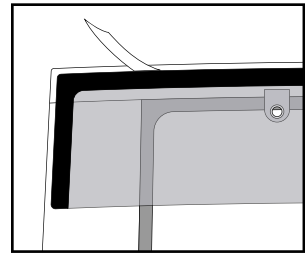
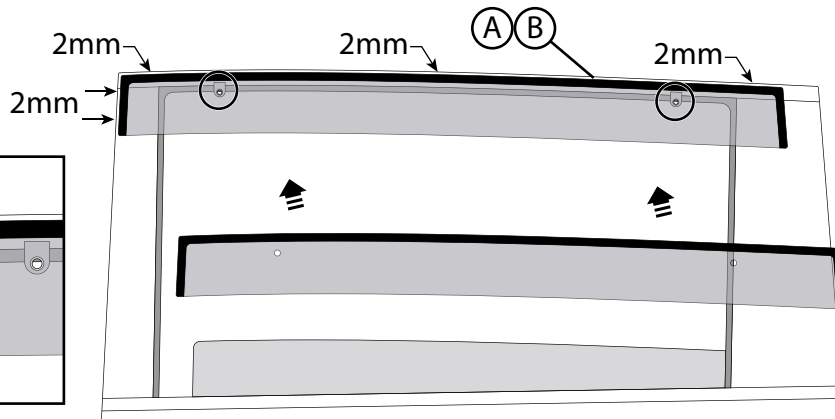

7

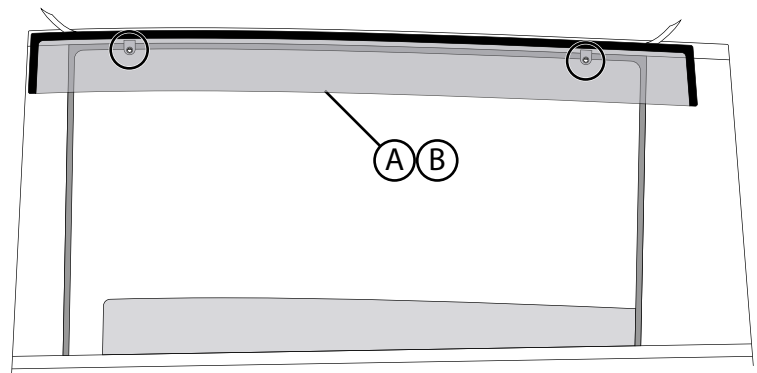
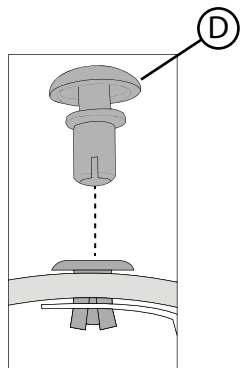
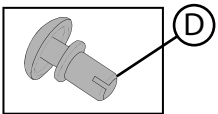

8

9

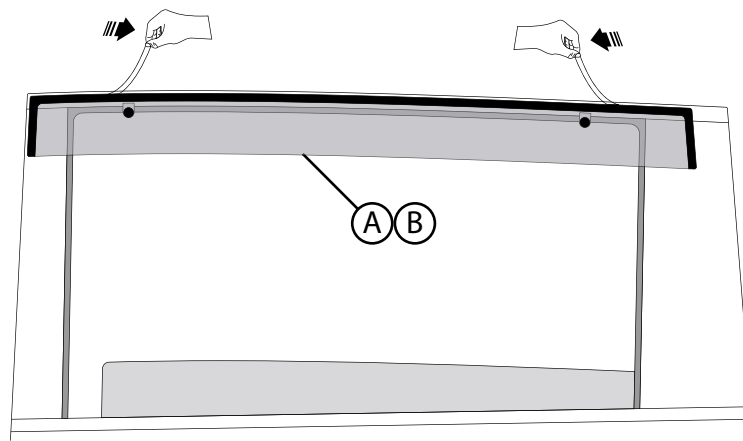

10

APPLY FIRM EVEN PRESSURE FOR 30 SECONDS
 APLIQUE PRESIÓN FIRME Y UNIFORME DURANTE 30 SEGUNDOS
 APPLIQUER DE LA PRESSION FERME ET ÉGALE PENDANT 30 SECONDES

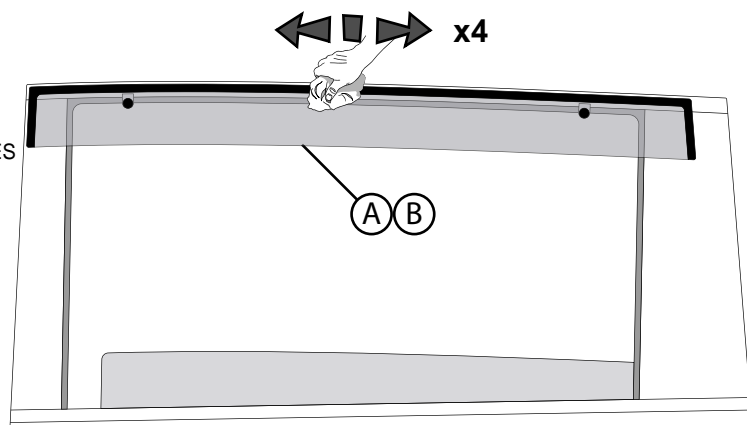

11

CYCLE WINDOWS OPEN/CLOSED AT LEAST 5 TIMES TO ENSURE
 SEAL IS INSTALLED PROPERLY
 REALICE CICLOS CON LAS VENTANAS ABIERTAS Y CERRADAS
 DURANTE AL MENOS 5 VECES PARA
 OUVRIR ET FERMER LES FENÊTRES AU MOINS 5 AFIN DE VÉRIFIER
 SI LE DISPOSITIF D'ÉTANCHÉITÉ EST BIEN INSTALLÉ

